



Project _____
 Item # _____
 Quantity _____

Rapide Cuisine® Built-In Induction Ranges

Models: IRNG-PB1-14, IRNG-PB1-18

Hatco's Rapide Cuisine® Built-In Professional Induction Range is designed and built for the rigors of commercial foodservice use. Its Magnetic Power System (MPS) delivers the highest power in its class!

This unit can be mounted flush or near flush with the optional trim ring. It has brains and beauty with a high resolution color display, timer, plus convenient power and temperature modes.

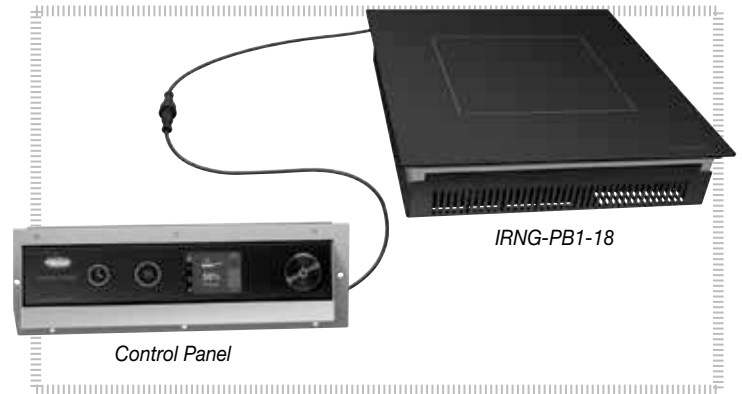

Standard features:

- High resolution TFT (thin film transistor) display instantly advises the operator of precise power (1 to 100), temperature (F° or C° in one degree increments) and time control (30 seconds to 10 hours)



- Programmable mode where the operator can create preset programs for consistent cooking cycles and quality product
- Easy to use, color-coded selectable functions
- Adaptive control knob adjusts to user input. From precise, fine control (slow turns) to spanning the full range in a single twist (fast turns)
- Pan Sense Technology (PST) activates the unit only when a suitable pan is placed on top
- Black ceramic glass top is both durable and easy to clean
- Fully-sealed top with conformal coated boards adds extra protection against grease or moisture
- Safety features and convenience features such as automatic shut-off to prevent overheating
- USB port below the control panel for downloading updates or adding modes from our website
- Includes remote control panel and cord
- 71" (1800 mm) cord with plug

Accessory (available for purchase at any time)

- Trim Ring* in Stainless Steel (holds unit nearly flush on a stainless steel counter)

**For use where chair-step routing of the countertop material is not possible, but a flush-mounted look is desired.*



ANSI/NSF 4

HATCO CORPORATION | P.O. Box 340500 Milwaukee, WI 53234-0500 U.S.A.
 (800) 558-0607 | (414) 671-6350 | www.hatcocorp.com | support@hatcocorp.com



Rapide Cuisine® Built-In Induction Ranges

Models: IRNG-PB1-14, -18

IRNG-PB1 Model

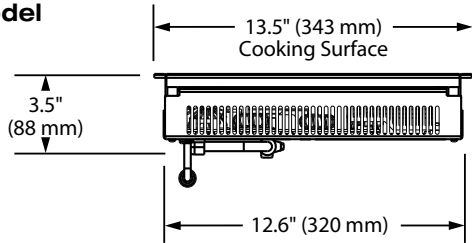

FRONT VIEW

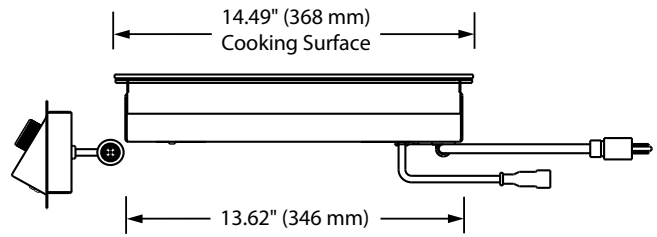

SIDE VIEW

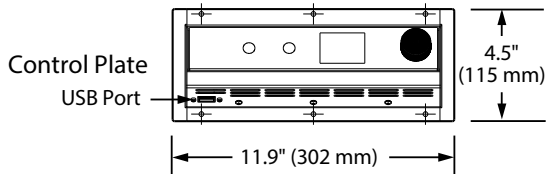

Cutout Dimensions for Control Panel

Model	Width	Height
IRNG-PB1-14, -18	11" (279 mm)	3.5" (89 mm)

IRNG-PB1 Model Cutout Dimensions

Cutout Dimensions for Flush Mount (thicker countertops)

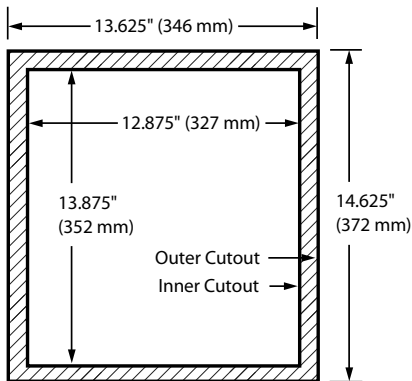

Cutout Dimensions for Flush Mount

Model	Outer Cutout		Inner Cutout	
	Width	Depth	Width	Depth
IRNG-PB1-14, -18	13.625" (346 mm)	14.625" (372 mm)	12.875" (327 mm)	13.875" (352 mm)

Cutout Dimensions for Trim Ring (holds unit nearly flush on a stainless steel countertop)

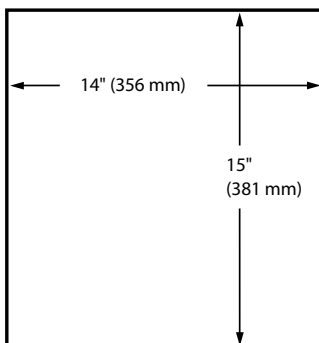

Cutout Dimensions for Trim Ring

Model	Width	Depth
IRNG-PB1-14, -18	14" (356 mm)	15" (381 mm)

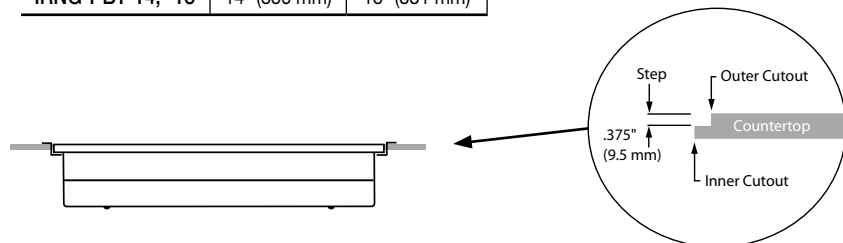



Rapide Cuisine® Built-In Induction Ranges

Models: IRNG-PB1-14, -18

SPECIFICATIONS Built-In Induction Ranges

Model	Dimensions (Width x Depth x Height)	Volts	Phase	Watts	Amps	Plug	Cord Location	Ship Weight*
IRNG-PB1-14	13.5" x 14.49" x 3.5" (343 x 368 x 88 mm)	120	Single	1440	12.0	NEMA 5-15P	Rear left bottom base corner	17 lbs. (8 kg)
IRNG-PB1-18	13.5" x 14.49" x 3.5" (343 x 368 x 88 mm)	120	Single	1800	15.0	NEMA 5-15P	Rear left bottom base corner	17 lbs. (8 kg)
						NEMA 5-20P ▲		

* Shipping weight includes packaging and is approximate.

▲ Canadian models use NEMA 5-20P.

PLUG CONFIGURATIONS

PAN SIZE

Maximum Pan Size: 13" diameter (330 mm), Minimum Pan Size: 4" diameter (102 mm)

NEMA 5-15P

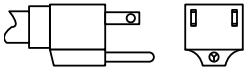

NEMA 5-20P

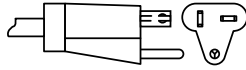

PRODUCT SPECS Rapide Cuisine® Built-In Induction Ranges

The Built-In Induction Range shall be a Rapide Cuisine® model, manufactured by the Hatco Corporation, Milwaukee, WI 53234 U.S.A.

The Induction Range shall be rated at ... watts, ... volts, single phase and be ... inches (millimeters) in overall width. The Built-In Induction Range shall consist of a stainless steel and aluminum housing with a single generator coil, a glass ceramic top surface and a 71" (1800 mm) cord and plug. It shall include a remote control box with a glass

touch panel, a color-coordinated control (CCC) for 0-100 power steps, temperature (F° or C°) and timer, an infinite control, a USB port (for software updates and operator selected modes) and a 71" (1800 mm) cable. The remote control box is connected to the main case with a quick disconnect connector.

Warranty consists of 24/7 parts and service assistance (US and Canada only).

HATCO CORPORATION | P.O. Box 340500 Milwaukee, WI 53234-0500 U.S.A.
 (800) 558-0607 | (414) 671-6350 | www.hatcocorp.com | support@hatcocorp.com